



Pricelist v1.3

YES[®]

Rental

Rue de la Paix, 24 - 26
B7500 Tournai - Belgium

Tel. +32 69 78 99 30

Fax +32 69 78 99 39

www.yesrental.be
rental@yesrental.be

YES Rental is a rental company for audio-visual equipment (sound, lighting, video, truss, Rigging, power, stage).

We offer a unique rental system and several collaboration opportunities to all the Europeans providers.

FRANCE

65 / 75 Avenue Jean Mermoz
Espace Paris Mermoz
Zone 8 - Bâtiment i
F93120 La Courneuve - France

Tel. +33 (0)1 49 21 18 20

Fax +33 (0)1 49 21 18 21

www.yesrental.fr
location@yesrental.fr

Quality listening and advise are the values that allow us to provide you with high quality, high maintenance and high performance equipment.

We respect the customer's expectations by always delivering the equipment within the requested time limits.

Our know-how and best performing machines are at your service to answer your project.

This catalogue gives you an overview of our various products and solutions.

Our fleet is constantly changing; so do not hesitate to contact us for a specific demand or simply to keep updated on our latest news.

Sound 4

Light 9

Video 16

Trussing 20

Rigging 25

Energy/Cabbling 28

Stage/Accessories 36

Various 39



Sound

| BRAND | TYPE | SPECIFICATIONS | PRICE / DAY € |
|-------|------|----------------|---------------|
|-------|------|----------------|---------------|

Floor Monitors

| | | | |
|-----|-------|-----------------------------------------|-------|
| APG | DX12 | Speaker coaxial - 400 Watts AES | 25,00 |
| APG | DX15 | Speaker coaxial - 600 Watts AES | 30,00 |
| APG | SMX15 | Speaker coaxial - biamp - 800 Watts AES | 35,00 |

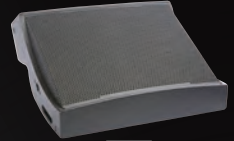

▶ APG
DX12

Full Range

| | | | |
|-----|-------|---------------------------------------|------------------|
| APG | DX5 | Speaker coaxial - 100 Watts AES | New 17,50 |
| APG | DX8 | Speaker coaxial - 200 Watts AES | 20,00 |
| APG | DX12 | Speaker coaxial - 400 Watts AES | 25,00 |
| APG | DX15 | Speaker coaxial - 600 Watts AES | 30,00 |
| APG | SMX15 | Speaker coaxial - biamp 800 Watts AES | New 35,00 |

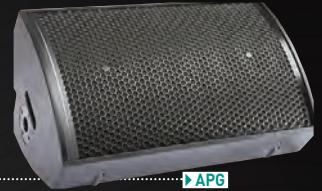

▶ APG
SMX15

Self-powered

| | | | |
|-----|---------|------------------|-------|
| JBL | PRX612M | Top - 800 Watts | 25,00 |
| JBL | PRX618S | Bass - 800 Watts | 35,00 |

Subs & Basses

| | | | |
|-----|---------|-----------------|------------------|
| JBL | PRX618S | 800 Watts | 35,00 |
| APG | SB115 | 700 Watts AES | 30,00 |
| APG | TB118S | 1 000 Watts AES | New 35,00 |



▶ APG
TB118S

Amplifiers & Processors

| | | | |
|-------------|---------|-------------------------|-------------------|
| L-Acoustics | LA48 | | 35,00 |
| APG | Rack 04 | 2 x SA30 + 1 Proc DMS26 | New 90,00 |
| APG | Rack 06 | 3 x SA30 + 1 Proc DMS26 | New 125,00 |
| APG | Rack 08 | 4 x SA30 + 1 Proc DMS48 | New 180,00 |



▶ APG
Rack

BRAND TYPE SPECIFICATIONS PRICE / DAY €

Rigging for Audio Equipment

| | | | |
|-------------|--------------------------|-----------------------------------|---------------|
| Yale | Varichain 0,2m → 2m - 2T | | 7,50 |
| ASD | Speaker stand | | 3,00 |
| ASD | Speaker pole | | 6,00 |
| VMB | TLA-320 | Stand for Line-Array (max 250 kg) | 65,00 |
| ASD | ST 780 | Tower for line-Array (max 500 kg) | 125,00 |

Equaliser

| | | | |
|------------|---------|----------------|--------------|
| BSS | FCS-966 | 31 band stereo | 25,00 |
|------------|---------|----------------|--------------|

Player / Recorder

| | | | |
|---------------|-------------|---------------------------|--------------|
| Tascam | SS-CDR1 PRO | CD P& MP3 - Compact Flash | 30,00 |
|---------------|-------------|---------------------------|--------------|

Intercoms / Talkies

| | | | |
|----------------|---------|----------------------------------------|--------------|
| ASL | IS140 | Sound & Light beacom | 10,00 |
| ASL | PS-19M | Metal single chanel belpack | 7,50 |
| ASL | DT109 | Headset double muff | 10,00 |
| ASL | DT108 | Headset single muff | 10,00 |
| ASL | PS-279 | 2 chanel master station | 20,00 |
| Kenwood | TK-3301 | Set of 4 x TR 3301 | 80,00 |
| Kenwood | TK-3301 | Talkie walkie TR 3301 | 20,00 |
| Kenwood | KMC-45 | Speaker mic, PTT | 5,00 |
| Kenwood | KHS-7A | Single muff headset with boom mic, PTT | 5,00 |
| Kenwood | KHS-9BL | 2-wire palm mic kit-vox ready | 7,00 |

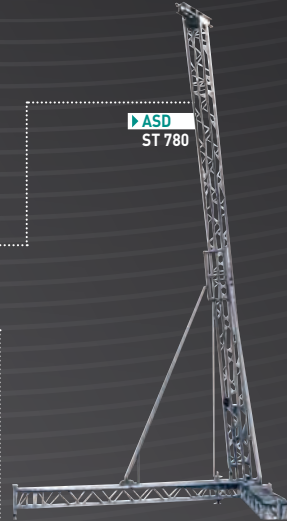
▶ ASD
ST 780▶ BSS
FCS-966▶ Tascam
SS-CDR1 PRO▶ Kenwood
4 x TR 3301

BRAND TYPE SPECIFICATIONS PRICE / DAY €

Analog Console

| | | | |
|--------------|------------|------------------------|--------------|
| Midas | Venice 16F | In : 8 mono + 4 stereo | 75,00 |
|--------------|------------|------------------------|--------------|

Digital Consoles

| | | | |
|-------------------|---------------|-------------------------|---------------|
| Soundcraft | Si compact 24 | In : 24 mono + 4 stereo | 100,00 |
| Soundcraft | Si2 | In : 48 mono + 4 stereo | 250,00 |
| Digico | SD8 | In : 60 mono or stereo | 450,00 |

Accessories - DI Box

| | | | |
|-----------------|--------|--------------------------------|--------------|
| BSS | AR 133 | DI Box | 10,00 |
| LA Audio | DBT | Dual balancing transfo 600 Ohm | 7,50 |

DJ'S

| | | | |
|-----------------|---------------|---------------------------------|--------------|
| Pioneer | DJM-900 Nexus | | 50,00 |
| Technics | SL-1200MK2 | Turntable | 25,00 |
| Maglev | | Magnetic leveller for turntable | 15,00 |
| Pioneer | CDJ-2000 | CD, mp3, USB | 75,00 |

Microphones

| | | | |
|--------------------------|-------------|--|--------------|
| AKG | C535EB | | 12,00 |
| AKG | C414 ULS | | 35,00 |
| AKG | CK47 + GN30 | | 25,00 |
| AKG | C520 | | 20,00 |
| AKG | D112 | | 10,00 |
| Brüel & Kjaer | 4007 | | 50,00 |
| Electrovoice | RE20 | | 20,00 |
| Neumann | KMS 105 | | 35,00 |
| Neumann | KM 184 | | 25,00 |
| Sennheiser | e906 | | 12,50 |
| Sennheiser | e904 | | 8,00 |
| Sennheiser | c604 | | 6,00 |
| Sennheiser | c845 | | 5,00 |
| Sennheiser | MD421 | | 10,00 |
| Shure | BETA 58A | | 6,00 |
| Shure | BETA 57A | | 6,00 |
| Shure | SM58 | | 5,00 |
| Shure | SM57 | | 5,00 |
| Shure | BETA 91 | | 20,00 |
| Shure | BETA 98D/S | | 20,00 |
| Shure | BETA 98H/S | | 20,00 |
| Shure | BETA 52 | | 10,00 |

▶ Soundcraft
Si compact 24▶ Digico
SD8▶ Pioneer
DJM-900 Nexus▶ Pioneer
CDJ-2000▶ AKG
C414 ULS▶ Neumann
KMS 105▶ Neumann
KM 184▶ Sennheiser
e904▶ Shure
BETA 58A▶ Shure
BETA 98D/S

| BRAND | TYPE | SPECIFICATIONS | PRICE / DAY € |
|----------------------------------------------------------|------------|--------------------------------------------------|---------------|
| Wireless Microphones (Receivers and transmitters) | | | |
| Shure | PGX 2 | (H6 → 524 - 542 MHz) - Handheld transmitter SM58 | 15,00 |
| Shure | PGX 1 | (H6 → 524 - 542 MHz) - Bodypack transmitter | 15,00 |
| Shure | PGX 4E | (H6 → 524 - 542 MHz) - Single receiver | 25,00 |
| Shure | UR4D Q5 | (Q5 → 740 - 814 MHz) - Double receiver | 80,00 |
| Shure | UR1 Q5 | (Q5 → 740 - 814 MHz) - Bodypack transmitter | 30,00 |
| Shure | UR2 Q5 | (Q5 → 740 - 814 MHz) - Handheld transmitter | 30,00 |
| Shure | KSM9 | Capsule micro | 10,00 |
| DPA | DP-4066 | Heidset beige - Mini XLR 4 pin | 50,00 |
| AKG | C520 | Heidset black - Mini XLR 4 pin | 20,00 |
| Shure | BETA 98D/S | Mini XLR 4 pin | 20,00 |
| Shure | BETA 98H/S | Mini XLR 4 pin | 20,00 |

Microphones stands

| | | |
|-----------|---------------------------------------|------|
| K&M | Normal stand - Long feet & long boom | 2,50 |
| K&M | Normal stand - Long feet & short boom | 2,50 |
| K&M | Small stand - Short feet & long boom | 2,50 |
| K&M | Small stand - Short feet & short boom | 2,50 |
| Adam hall | Normal stand - Long feet & long boom | 2,00 |

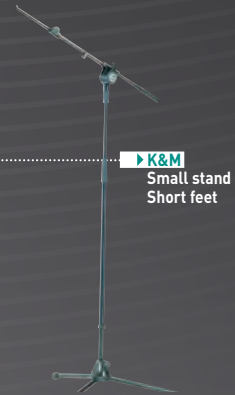



Light

BRAND TYPE SPECIFICATIONS PRICE / DAY €

Light Controllers

| | | | |
|-------------|---------------------|--------------------------------|------------------|
| Jands | Stage CL | 1 x 512 DMX | New 50,00 |
| Jands | Vista S1 | 2 x 512 DMX (PC + 50,00 euros) | 100,00 |
| Jands | Vista T2 | 4 x 512 DMX | 300,00 |
| MA Lighting | GrandMA2 light | 6 x 512 DMX | 400,00 |
| MA Lighting | GrandMA2 full-size | 6 x 512 DMX | 500,00 |
| MA Lighting | GrandMA2 fader wing | | 90,00 |



► MA Lighting
GrandMA2 full-size

Splitter DMX / Ethernet

| | | | |
|-------------|--------------|-------------------------------|--------|
| Allied | AT-FS708 | 8 x Ethernet | 20,00 |
| MA Lighting | NPU | 8 x DMX out | 175,00 |
| OXO | 2 x (B)Box 6 | 2 x 3/5 in → 12 x DMX 3/5 out | 40,00 |
| OXO | 4 x (B)Box 6 | 4 x 3/5 in → 24 x DMX 3/5 out | 80,00 |

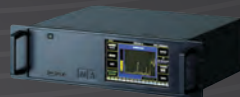

► MA Lighting
NPU

Dimmers

| | | | |
|-------------|---------------|----------|--------|
| MA Lighting | 12 x 2,3 Kw | 63A Tri | 60,00 |
| MA Lighting | 12 x 3,7 Kw | 63A Tri | 75,00 |
| MA Lighting | 24 x 2,3 Kw | 125A Tri | 120,00 |
| MA Lighting | 24 x 3,7 Kw | 125A Tri | 150,00 |
| ADB | 6 x 2 Kw | 32A Tri | 45,00 |
| ADB | 12 x 2 Kw | 63A Tri | 60,00 |
| OXO | 1 x 2 Kw | Shuko | 10,00 |
| OXO | 4 x 650 Watts | Shuko | 17,50 |



► PixelRANGE
QPar

LED Projector

| | | | | |
|------------|-------------------------|------------------------------------|-----|------------------|
| OXO | MiniBeam FCW | PAR - 7 x 5 W RGBW Full Color | 10° | 12,50 |
| OXO | MiniBeam FCW IR | PAR - 7 x 5 W RGBW Full Color - IR | 10° | 15,00 |
| OXO | Multibeam FCW | PAR - 18 x 5 W RGBW Full Color | 25° | 20,00 |
| Luxibel | LX107 | PAR - 18 x 10 W RGBW Full Color | 17° | New 25,00 |
| PixelRANGE | QPar | PAR LED RGBW Full Color | 10° | 45,00 |
| ChromaQ | ColorForce 12 | Bar - RVBA | | 35,00 |
| ADB | ALC 4/2 | Bar - RGBW Full Color | | 85,00 |
| PixelRANGE | SMARTLINE | Bar - RGBW Full Color | | 95,00 |
| Ayrtec | Rollapix 100 | Bar - RGBW Full Color | | New 60,00 |
| Showtec | Spectral 2500 Zoom IP65 | | | New 35,00 |



► ChromaQ
ColorForce 12

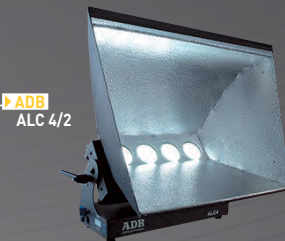

► ADB
ALC 4/2

LED Accessories

| | | | |
|------------|----------------|----------------------|------------------|
| ADB | Reflector ALC4 | Flap reflector | 10,00 |
| ADB | Reflector ALC4 | Asymmetric reflector | 7,00 |
| PixelRange | QPar Lens | 20° or 34° | New 10,00 |



► PixelRANGE
SMARTLINE

MARQUE MODÈLE DESCRIPTION PRIX / JOUR €

Intelligent Lights Spot

| | | | |
|------|-----------------|----------------------------------------|--------|
| Robe | Robin 600E spot | 575 Watts - MSR Gold 575/2 MiniFastFit | 95,00 |
| Robe | Robin MMX spot | 800 Watts - MSR Platinum 35 | 135,00 |

Intelligent Lights Profile

| | | | |
|-----------|---------------------|-----------------------------|-------------------|
| Clay Paky | Alpha 700 Profile | 700 Watts - MSR | 145,00 |
| Robe | Robin MMX Wash/Beam | 800 Watts - MSR Platinum 35 | New 145,00 |

Intelligent Lights Wash

| | | | |
|------|---------------------|---------------------------------------------|-------------------|
| Robe | Robin 100 Beam | 12 x 15 Watts LED Full Color | New 45,00 |
| Robe | Robin 300 LedWash | 19 x 10 Watts LED Full Color Zoom 15° - 60° | 55,00 |
| Robe | Robin 600 LedWash | 37 x 10 Watts LED Full Color Zoom 15° - 60° | 75,00 |
| Robe | Robin 1200 LedWash | 61 x 15 Watts LED Full Color Zoom 8° - 63° | 135,00 |
| Robe | Robin MMX Wash/Beam | 800 Watts - MSR Platinum 35 | New 145,00 |

Intelligent Lights Beam

| | | | |
|------|---------------------|------------------------------|-------------------|
| Robe | Robin 100 Beam | 12 x 15 Watts LED Full Color | 45,00 |
| Robe | Robin MMX Wash/Beam | 800 Watts - MSR Platinum 35 | New 145,00 |

Exterior Light

| | | | |
|------------|------------|-----------------|--------|
| Studio Due | City Color | 2 500 Watts-HMI | 125,00 |
|------------|------------|-----------------|--------|



▶ Robe
MMX Wash/Beam



▶ Robe
100 Beam



▶ Robe
600 LedWash



▶ Robe
1200 LedWash

| BRAND | TYPE | SPECIFICATIONS | PRICE / DAY € | |
|--------------------------------------------------------|----------|-------------------------|----------------|-------|
| Profiles (with spigot 28 mm & C100 Avenger) | | | | |
| Robert Juliat | 611 SX | 11° - 26° | 1 Kw or 1,2 Kw | 20,00 |
| Robert Juliat | 613 SX | 28° - 54° | 1 Kw or 1,2 Kw | 17,50 |
| Robert Juliat | 614 SX | 16° - 35° | 1 Kw or 1,2 Kw | 17,50 |
| Robert Juliat | 710 SX2 | 10° - 25° | 2 Kw or 2,5 Kw | 30,00 |
| Robert Juliat | 713 SX2 | 29° - 50° | 2 Kw or 2,5 Kw | 25,00 |
| Robert Juliat | 714 SX2 | 15° - 40° | 2 Kw or 2,5 Kw | 25,00 |
| Robert Juliat | Iris | Iris | | 5,00 |
| Robert Juliat | Gobo | Gobo holder | | 5,00 |
| ETC | Source 4 | 5° - 10° - 14° | Lens Tube | 15,00 |
| ETC | Source 4 | 19° - 26° - 36° - 50° | Lens Tube | 10,00 |
| ETC | Source 4 | 15° → 30° - 25° → 50° | Lens Tube Zoom | 15,00 |
| ETC | Source 4 | Luminaire body assembly | 750 W HPL | 10,00 |
| ETC | Iris | Iris | | 5,00 |
| ETC | Gobo | Gobo holder | | 5,00 |

(Knives & filter frame included)

| LED for Profiles | | | |
|-------------------------|-----------|---------------------------------------------------|-----------|
| BB&S | Aledin II | 3 200 k° - CRI 72 - (for Robert Juliat 600 serie) | 30,00 |
| BB&S | Aledin II | 5 600 k° - CRI 80 - (for Robert Juliat 600 serie) | 30,00 |
| BB&S | Force V | 3 200 k° - CRI 94 - (for ETC Source 4) | New 30,00 |
| BB&S | Force V | 5 600 k° - CRI 92 - (for ETC Source 4) | New 30,00 |

| Tungsten Fresnel (with spigot 28 mm & C100 Avenger) | | | | |
|----------------------------------------------------------------|-------------|-----------|---------------|-------|
| ARRI | 300 Plus | 300 Watts | Black | 13,00 |
| ARRI | 650 Plus | 650 Watts | Black | 15,00 |
| ARRI | ST1 | 1 Kw | Pole Operated | 20,00 |
| ARRI | ST2/3 | 2/3 Kw | Pole Operated | 25,00 |
| ARRI | ST5 | 5 Kw | Pole Operated | 30,00 |
| Filmgear | Studio 650 | 650 Watts | | 13,00 |
| Filmgear | Studio 1000 | 1 Kw | Pole Operated | 17,50 |
| Filmgear | Studio 2000 | 2 Kw | | 22,50 |

| LED Fresnels (with spigot 28mm & C100 Avenger) | | | | |
|-----------------------------------------------------------|-------------|---------------|-----------|-----------|
| ARRI/ BB&S | ST1 | CRI 80 | (5 600°k) | New 50,00 |
| De Sisti/BB&S | Ledonardo 1 | Pole Operated | (5 600°k) | 45,00 |
| De Sisti/BB&S | Ledonardo 2 | Pole Operated | (5 600°k) | 50,00 |

| Tungsten PC | | | | |
|--------------------|------|----------|-------------|-------|
| ADB | C103 | 7° - 61° | 1 000 Watts | 11,00 |

▶ Robert Juliat
Aledin 634 SX▶ ETC/BB&S
Force V▶ Filmgear
Studio 2000▶ ARRI/ BB&S
ST1

BRAND TYPE SPECIFICATIONS PRICE / DAY €

Tungsten Blinder

| | | | | |
|-----------|----------|---------------------|-----|-------|
| Varytec | FL650 | 1 x DWE 650 Watts | | 10,00 |
| Luxibel | FL1300 | 2 x DWE 650 Watts | DMX | 15,00 |
| Luxibel | FL2600 | 4 x DWE 650 Watts | DMX | 22,00 |
| Luxibel | Molefay | 8 x DWE 650 Watts | | 35,00 |
| Showtec | Sunstrip | T10 - 10 x 75 Watts | DMX | 15,00 |
| Chromlech | Jarag 5 | 25 x PAR 30 | DMX | 45,00 |

LED Blinder

| | | | | |
|-----------|-----------|-------------------------|------------|-------------------|
| Oxo | Funstrip | T10 actif | | New 25,00 |
| Chromlech | Elidy-S | 25 x LED | | New 35,00 |
| Chromlech | Elidy-Big | 225 x LED (PSU incl.) | DMX/Artnet | New 290,00 |
| Chromlech | PSU Elidy | Max 9 x Elidy-S par PSU | DMX/Artnet | New 40,00 |
| Luxibel | LX109 | 16 x Tricolor COB LED | 10 Watts | New 35,00 |

Tungsten PAR

| | | | | |
|---------|------------|--------|---------------------------|-------|
| Varytec | PAR 30 | | 75 Watts | 4,00 |
| Thomas | PAR 64 | CP60 | 1 000 Watts | 5,50 |
| Thomas | PAR 64 | CP61 | 1 000 Watts | 5,50 |
| Thomas | PAR 64 | CP62 | 1 000 Watts | 5,50 |
| Thomas | 6 x PAR 64 | CP60 | 6 x 1 000 Watts - Harting | 32,50 |
| Thomas | 6 x PAR 64 | CP62 | 6 x 1 000 Watts - Harting | 32,50 |
| Thomas | 8 x PAR64 | ACL | 8 x 250 Watts - 28 Volts | 45,00 |
| Thomas | Gel frame | PAR 64 | | 0,50 |
| OXO | S4 - Black | | 575 Watts | 4,00 |
| ETC | S4 - Black | | 575 Watts | 8,00 |

Follow Spots

| | | | | |
|---------------|----------------------------------|-----------|------------|-------------------|
| Robert Juliat | Super Korrigan | 7°- 14,5° | 1,2 KW HMI | 135,00 |
| Robert Juliat | Flo | 13°- 24° | 1,8 KW MSR | New 250,00 |
| Robert Juliat | Cyrano | 3°- 8° | 2,5 KW HMI | 280,00 |
| Prolyte | Universal chair for Follow Spots | | | 80,00 |

▶ Luxibel
FL1300▶ Chromlech
Jarag 5▶ Chromlech
Elidy-S▶ Chromlech
Elidy-Big▶ Luxibel
LX109▶ Robert Juliat
Super Korrigan

| BRAND | TYPE | SPECIFICATIONS | PRICE / DAY € |
|------------------------------------------------------------------|---------|----------------|---------------|
| Tungsten Open Face (with spigot 28 mm & C100 Avenger) | | | |
| ARRI | Redhead | 800 Watts | 12,00 |
| ARRI | Blonde | 2 Kw | 16,00 |

| Soft Light LED | | | |
|-----------------------|---------------------------------------------|--------------|------------------|
| BB&S | Area 48 | | New 40,00 |
| BB&S | Accessory Area 48 high - CRI 97 | 3 200° K | New 10,00 |
| BB&S | Accessoire Area 48 high - CRI 95 | 4 300° K | New 10,00 |
| BB&S | Accessory Area 48 high - CRI 96 | 5 600° K | New 10,00 |
| BB&S | Accessory Area 48 high CRI Media | Chroma-Green | New 20,00 |
| Rosco | Lite Pad - 7,62 x 15,64 cm (Transfo incl.) | Day Light | New 20,00 |
| Rosco | Lite Pad - 15,24 x 30,48 cm (Transfo incl.) | Day Light | New 30,00 |

| Flood Light & Discharge Lamps | | | |
|------------------------------------------|--------------|--------------------|------------------|
| ADB | Asymmetric | ACP 1 001 Tungsten | 1250 Watts 10,00 |
| Philips | Symmetric | Quartz Tungsten | 500 Watts 2,50 |
| Philips | Symmetric | Quartz Tungsten | 500 Watts 5,00 |
| Philips | Asymmetric | HQI 400 Watts | 10,00 |
| Philips | IP65 - 1,2 m | TL | 36 Watts 5,00 |

| Exhibition Lamp | | | |
|------------------------|------|------------------------|----------------------------------|
| YES | Spot | dichroic lamp with arm | 50 Watts - 12 V New 10,00 |

| Lighting Effects | | | |
|-------------------------|-------------|-----------------|-------|
| Martin | Atomic 3000 | Stroboscope DMX | 25,00 |
| Showtec | Moon | LED Effect | 15,00 |



▶ **BB&S**
Area 48



▶ **Rosco**
Lite Pad

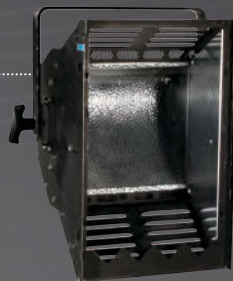

▶ **ADB**
ACP 1001



▶ **YES**
Dichroic Spot

▶ **Martin**
Atomic 3000



BRAND TYPE SPECIFICATIONS PRICE / DAY €

Accessories

| | | | |
|------------------|----------------|-----------------------------------------------------|-------|
| Manfrotto | Auto pole | 2,1 → 3,7 m | 15,00 |
| Manfrotto | Operating pole | 1,9 → 4,0 m | 12,50 |
| Manfrotto | Operating pole | 2,2 → 6,5 m | 15,00 |
| Manfrotto | G200 | Ballast - 10 kg | 7,50 |
| Manfrotto | 143N | Magic Arm | 7,50 |
| Avenger | C825 | Telescopic Hanger & Unihead | 10,00 |
| Avenger | C825 baby | Telescopic Hanger & Unihead | 10,00 |
| Avenger | C100 | A clamp that works on diameters from 20 mm to 55 mm | 1,00 |
| Showtec | Outdoor Dome | | 45,00 |

Smoke - Fog - Haze - Fan

| | | | | |
|----------------|---------------|-------------|-----------------------------------------|--------|
| JEM | K1 | Hazer - DMX | 1 L. oil incl. | 90,00 |
| Real FX | DF50 | Fog | 1 L. oil incl. New | 100,00 |
| Swefog | Ultimate 2000 | Fog - DMX | 1 L. oil incl. | 100,00 |
| Swefog | Ultimate 3000 | Fog - DMX | 1 L. oil incl. | 125,00 |
| MDG | MAX 3000 | Smoke | 1 L. oil incl. + 1,5 kg CO ² | 100,00 |
| Martin | AF-1 | Fan | | 30,00 |

Mirror Balls - Motors

| | | | |
|------------|-------|--------|--------|
| YES | | 30 cm | 5,00 |
| YES | | 40 cm | 9,00 |
| YES | | 50 cm | 12,00 |
| YES | | 100 cm | 100,00 |
| YES | Motor | Small | 3,00 |
| YES | Motor | Large | 25,00 |

▶ Showtec
Outdoor
Dome▶ Real FX
DF50▶ Swefog
Ultimate
3000▶ Martin
AF-1



Video

Video

YES
Rental

BRAND TYPE SPECIFICATIONS PRICE / DAY €

LED Wall

| | | | | |
|---------------|----|--------|-----------------|----------------------------------------------------------------------|
| Pixled | F3 | 3,9 mm | 500 mm x 500 mm | Price/week : 280,00 Price/m ² : 1 120,00 |
|---------------|----|--------|-----------------|----------------------------------------------------------------------|

LED Wall Processor

| | | | |
|---------------|--------------|-------------------|------------------------------|
| Pixled | F3 Processor | + Folsom Imagepro | Price/week : 1 400,00 |
|---------------|--------------|-------------------|------------------------------|

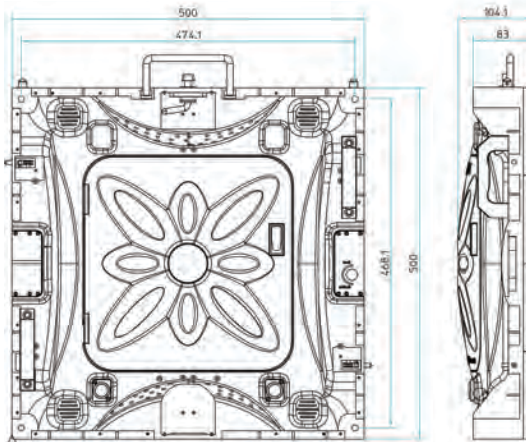
**LED Display**

| | | | |
|----------------|-----|------------------------|---------------|
| Samsung | 46" | Smart Interaction - 3D | 180,00 |
| Samsung | 55" | Smart Interaction - 3D | 225,00 |
| Samsung | 65" | Smart Interaction - 3D | 400,00 |
| Samsung | 75" | Smart Interaction - 3D | 600,00 |

LED Display - Accessorie

| | | |
|------------|------------------|--------------|
| YES | Stand for screen | 30,00 |
|------------|------------------|--------------|



► **Pixled**
F3



► **Samsung**
Smart Interaction - 3D

| BRAND | TYPE | SPECIFICATIONS | | | PRICE / DAY € |
|-------------------------------------|------------------|----------------|---------------|----------|---------------------|
| HD Projectors (without lens) | | | | | |
| Christie | DHD775-E HD | 1920 x 1080 | 7 000 lumens | Mono DLP | New 500,00 |
| Christie | ROADSTER HD14K-M | 1920 x 1080 | 14 000 lumens | Tri DLP | New 1 700,00 |
| Barco | HDQ-2K40 | 2048 x 1080 | 40 000 lumens | Tri DLP | New 4 500,00 |

Lens

Christie E-Series

| | | |
|----------|-------------------------------|--------|
| Christie | 0,8 : 1 Fixed Lens | 100,00 |
| Christie | 1,2 - 1,5 : 1 Short Zoom Lens | 75,00 |
| Christie | 1,5 - 2,0 : 1 Zoom Lens | 75,00 |
| Christie | 2,0 - 4,0 : 1 Zoom Lens | 100,00 |
| Christie | 4,0 - 7,0 : 1 Long Zoom Lens | 100,00 |

Christie M-Series

| | | |
|----------|--------------------------------|--------|
| Christie | ILS 0,73 : 1SX +/-0,67 : 1 HD | 220,00 |
| Christie | ILS 1,2SX +/-1.1 HD | 220,00 |
| Christie | ILS 1,25-1,6SX +/-1,16-1,49 HD | 300,00 |
| Christie | ILS 1,5-2,0SX +/-1,4-1,8 HD | 200,00 |
| Christie | ILS 2,0-2,8SX +/-1,4-1,8 HD | 200,00 |
| Christie | ILS 2,8-4,5SX +/-2,6-4,1 HD | 200,00 |
| Christie | ILS 4,5-7,3SX +/-4,1-6,9 HD | 200,00 |
| Christie | ILS 7,5-11,2SX +/-6,9-10,4 HD | 300,00 |

Barco HDQ

| | | |
|-------|---------------------|-------------------|
| Barco | Fixed lens 1.0 : 1 | New 450,00 |
| Barco | Zoom lens 1.4 - 1.8 | 450,00 |
| Barco | Zoom lens 1.8 - 2.4 | 450,00 |
| Barco | Zoom lens 2.8 - 5.5 | 450,00 |
| Barco | Zoom lens 5.5 - 8.5 | 500,00 |



► Christie
DHD775-E HD



► Christie
ROADSTER HD14K-M



► Barco
HDQ-2K40



► Christie
Lentilles

BRAND TYPE SPECIFICATIONS PRICE / DAY €

Projection Screen - Size 4/3 (Front & Retro)

| | | | |
|---------|-------------|--------------------------------------------------|--------|
| Stumplf | Monoblox 32 | Screen 2,64 x 2,03 - Projection Area 2,44 x 1,83 | 65,00 |
| Stumplf | Monoblox 32 | Screen 3,45 x 2,64 - Projection Area 3,25 x 2,44 | 85,00 |
| Stumplf | Vario 64 | Screen 4,00 x 3,00 - Projection Area 3,80 x 2,80 | 140,00 |
| Stumplf | Vario 64 | Screen 6,00 x 4,50 - Projection Area 5,80 x 4,30 | 200,00 |

Projection Screen - Size 16/9 (Front & Retro)

| | | | |
|---------|-------------|--------------------------------------------------|--------|
| Stumplf | Monoblox 32 | Screen 2,86 x 1,70 - Projection Area 2,66 x 1,50 | 80,00 |
| Stumplf | Monoblox 32 | Screen 3,86 x 2,26 - Projection Area 3,66 x 2,06 | 90,00 |
| Stumplf | Vario 64 | Screen 4,00 x 2,35 - Projection Area 3,80 x 2,15 | 100,00 |
| Stumplf | Vario 64 | Screen 5,00 x 2,90 - Projection Area 4,80 x 2,70 | 175,00 |
| Stumplf | Vario 64 | Screen 6,00 x 3,45 - Projection Area 5,80 x 3,25 | 200,00 |
| Stumplf | Vario 64 | Screen 7,00 x 4,00 - Projection Area 6,80 x 3,80 | 340,00 |

Distribution Amplifiers

| | | | |
|--------|-----------|-------------------------------|-------|
| Kramer | VP-200k | Splitter UXGA 1 → 2 | 25,00 |
| Kramer | VP-4xl | Splitter UXGA 1 → 4 | 35,00 |
| Kramer | VP-5xl | Splitter UXGA 1 → 5 | 35,00 |
| Kramer | VM-4HDMI | Splitter HDMI 1.3 - 1 → 4 | 40,00 |
| Kramer | VM-28HDMI | Splitter HDMI 1.3 - 2 x 1 → 4 | 65,00 |

Signal Processors

| | | | |
|------------------|-------------------|---------------------------------------|-------|
| Blackmagicdesign | Battery Converter | HDMI to SDI | 25,00 |
| Blackmagicdesign | Battery Converter | SDI to HDMI | 25,00 |
| DVIGEAR | DVI-3510a | HDMI to DVI + Digital Audio Converter | 25,00 |
| DVIGEAR | DVI-3150a | DVI + Digital Audio to HDMI Converter | 25,00 |
| DVIGEAR | DVI-3310b | VGA / HDTV to DVI Converter | 25,00 |
| DVIGEAR | DVI-3130b | DVI to VGA / HDTV Converter | 25,00 |

Multiformat Switcher

| | | |
|--------|--------|--------|
| Kramer | VP-728 | 100,00 |
|--------|--------|--------|

Video Source

| | | |
|-----------|----------|-------|
| Panasonic | Blue-Ray | 25,00 |
|-----------|----------|-------|

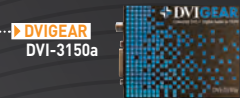
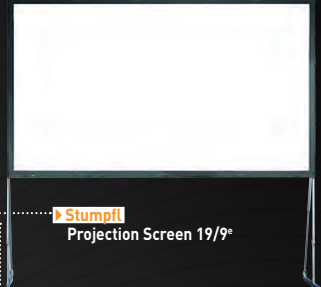
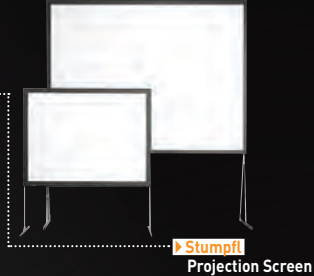



Trussing

| BRAND | TYPE | SPECIFICATIONS | PRICE / DAY € |
|-------------------------------|------------|----------------------|---------------|
| Trussing - Tube Silver | | | |
| ASD | EX50 L050 | 0,50 m | 1,00 |
| ASD | EX50 L100 | 1 m | 1,00 |
| ASD | EX50 L200 | 2 m | 2,00 |
| ASD | EX50 L300 | 3 m | 3,00 |
| ASD | EX5034 | 3-way corner T-Joint | 3,00 |
| LS Diffusion | Piping Set | 10 x H | 100,00 |

| | | | |
|------------------------------|------------|----------------------|--------------------|
| Trussing - Tube black | | | |
| ASD | EX50 L050 | 0,50 m | New! 2,00 |
| ASD | EX50 L100 | 1 m | New! 2,00 |
| ASD | EX50 L200 | 2 m | New! 3,00 |
| ASD | EX50 L300 | 3 m | New! 4,00 |
| ASD | EX5034 | 3-way corner T-Joint | New! 4,00 |
| LS Diffusion | Piping Set | 10 x H | New! 120,00 |

| | | | |
|---------------------------------------|------------------|----------------------------|-------|
| Trussing 300 - Triangle Silver | | | |
| Prolyte / ASD | X30D L029 | 0,29 m | 4,00 |
| Prolyte / ASD | X30D L050 | 0,50 m | 4,00 |
| Prolyte / ASD | X30D L071 | 0,71 m | 4,00 |
| Prolyte / ASD | X30D L100 | 1 m | 3,00 |
| Prolyte / ASD | X30D L200 | 2 m | 6,00 |
| Prolyte / ASD | X30D L300 | 3 m | 9,00 |
| Prolyte / ASD | X30D C003 | 2-way corner 90° | 7,50 |
| Prolyte / ASD | X30D C007 | 2-way corner 90° Apex Down | 7,50 |
| Prolyte / ASD | X30D C012 | 3-way corner 90° Apex Down | 10,00 |
| Prolyte / ASD | X30D C013 | 3-way corner 90° Apex Down | 10,00 |
| Prolyte / ASD | X30D C016 | 4-way corner cross | 10,00 |
| Prolyte / ASD | X30D C017 | 3-way T-Joint hor. | 10,00 |
| Prolyte / ASD | X30D C018 | 3-way T-Joint ver. | 10,00 |
| Prolyte / ASD | X30D C020 | 4-way T-joint Apex Down | 12,50 |
| Prolyte / ASD | X30D C021 | 5-way vert. vert. | 12,50 |
| Prolyte / ASD | X30D C024 | 5-way hor. Apex Down | 15,00 |
| Prolyte / ASD | Book Corner | Variangle 30 D&V | 17,50 |
| YES | Base Plate | | 5,00 |
| ASD | Heavy base plate | 80 cm ø - 60 kg | 15,00 |
| Axcept | Heavy base plate | 1 m x 1 m - 50 kg | 9,00 |

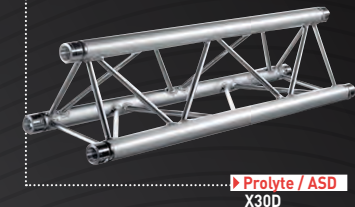
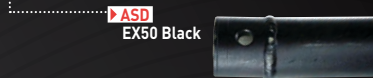

| BRAND | TYPE | SPECIFICATIONS | PRICE / DAY € |
|--------------------------------------|------------------|----------------------------|---------------|
| Trussing 300 - Triangle Black | | | |
| Prolyte / ASD | X30D L029 | 0,29 m | 5,00 |
| Prolyte / ASD | X30D L050 | 0,50 m | 5,00 |
| Prolyte / ASD | X30D L071 | 0,71 m | 5,00 |
| Prolyte / ASD | X30D L100 | 1 m | 4,00 |
| Prolyte / ASD | X30D L200 | 2 m | 8,00 |
| Prolyte / ASD | X30D L300 | 3 m | 12,00 |
| Prolyte / ASD | X30D C003 | 2-way corner 90° | 10,00 |
| Prolyte / ASD | X30D C007 | 2-way corner 90° Apex Down | 10,00 |
| Prolyte / ASD | X30D C012 | 3-way corner 90° Apex Down | 12,50 |
| Prolyte / ASD | X30D C013 | 3-way corner 90° Apex Down | 12,50 |
| Prolyte / ASD | X30D C016 | 4-way corner cross | 12,50 |
| Prolyte / ASD | X30D C017 | 3-way T-Joint hor. | 12,50 |
| Prolyte / ASD | X30D C018 | 3-way T-Joint ver. | 12,50 |
| Prolyte / ASD | X30D C020 | 4-way T-joint Apex Down | 15,00 |
| Prolyte / ASD | X30D C021 | 5-way vert. | 15,00 |
| Prolyte / ASD | X30D C024 | 5-way hor. Apex Down | 17,50 |
| Prolyte / ASD | Book Corner | Variangle 30 D&V | 20,00 |
| YES | Base Plate | | 7,50 |
| ASD | Heavy base plate | 80 cm ø - 60 kg | 20,00 |

▶ Prolyte / ASD
X30D - Black▶ ASD
ST 500

| | | | |
|------------------------------------|--------|-------------|------------------|
| Trussing 500 - Triangle Alu | | | |
| ASD | ST 500 | 0,8 m | New 10,00 |
| ASD | ST 500 | 1,20 m | New 13,00 |
| ASD | ST 500 | 2,40 m | New 17,00 |
| ASD | ST 500 | Cross 4 way | New 20,00 |

| | | | |
|--------------------------------------|--------|-------------|------------------|
| Trussing 500 - Triangle Black | | | |
| ASD | ST 500 | 0,8 m | New 12,00 |
| ASD | ST 500 | 1,20 m | New 15,00 |
| ASD | ST 500 | 2,40 m | New 20,00 |
| ASD | ST 500 | Cross 4 way | New 24,00 |

| | | | |
|-------------------------------------|--------------------------------------|--------------------|-------|
| Trussing 300 - Square Silver | | | |
| Prolyte / ASD | H30V L029 | 0,29 m | 5,00 |
| Prolyte / ASD | H30V L050 | 0,50 m | 5,00 |
| Prolyte / ASD | H30V L071 | 0,71 m | 5,00 |
| Prolyte / ASD | H30V L100 | 1 m | 4,00 |
| Prolyte / ASD | H30V L200 | 2 m | 8,00 |
| Prolyte / ASD | H30V L300 | 3 m | 12,00 |
| Prolyte / ASD | H30V C003 | 2-way corner 90° | 10,00 |
| Prolyte / ASD | H30V C012 | 3-way corner 90° | 12,50 |
| Prolyte / ASD | H30V C016 | 4-way corner cross | 12,50 |
| Prolyte / ASD | H30V C017 | 3-way T-Joint | 12,50 |
| Prolyte / ASD | H30V C020 | 4-way T-joint | 15,00 |
| Prolyte / ASD | H30V C024 | 5-way T-joint | 15,00 |
| Prolyte / ASD | Book Corner | Variangle 30 D&V | 17,50 |
| YES | Base Plate | | 5,00 |
| ASD | Heavy base plate - 80 cm ø - 60 kg | | 15,00 |
| Azept | Heavy base plate - 1 m x 1 m - 50 kg | | 9,00 |

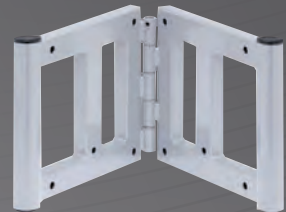
▶ Prolyte / ASD
H30V▶ Prolyte / ASD
Book Corner

| BRAND | TYPE | SPECIFICATIONS | PRICE / DAY € |
|------------------------------------|------------------|--------------------|---------------|
| Trussing 300 - Square Black | | | |
| Prolyte / ASD | H30V L029 | 0,29 m | 7,00 |
| Prolyte / ASD | H30V L050 | 0,50 m | 7,00 |
| Prolyte / ASD | H30V L071 | 0,71 m | 7,00 |
| Prolyte / ASD | H30V L100 | 1 m | 6,00 |
| Prolyte / ASD | H30V L200 | 2 m | 12,00 |
| Prolyte / ASD | H30V L300 | 3 m | 18,00 |
| Prolyte / ASD | H30V C003 | 2-way corner 90° | 12,00 |
| Prolyte / ASD | H30V C012 | 3-way corner 90° | 14,50 |
| Prolyte / ASD | H30V C016 | 4-way corner cross | 14,50 |
| Prolyte / ASD | H30V C017 | 3-way T-Joint | 14,50 |
| Prolyte / ASD | H30V C020 | 4-way T-joint | 18,00 |
| Prolyte / ASD | H30V C024 | 5-way T-joint | 18,00 |
| Prolyte / ASD | Book Corner | Variangle 30 D&V | 20,00 |
| YES | Base Plate | | 7,50 |
| ASD | Heavy base plate | 80 cm ø - 60 kg | 20,00 |

| | | | |
|----------------------------------------|------------|--------|------------------|
| Trussing 400 - Rectangle silver | | | |
| Prolyte | H40R L050 | 0,5 m | New 8,00 |
| Prolyte | H40R L071 | 0,71 m | New 8,00 |
| Prolyte | H40R L100 | 1 m | New 6,00 |
| Prolyte | H40R L200 | 2 m | New 12,00 |
| Prolyte | H40R L300 | 3 m | New 18,00 |
| Prolyte | Box Corner | | New 20,00 |

| | | | |
|---------------------------------------|------------|--------|------------------|
| Trussing 400 - Rectangle Black | | | |
| Prolyte | H40R L050 | 0,5 m | New 10,00 |
| Prolyte | H40R L071 | 0,71 m | New 10,00 |
| Prolyte | H40R L100 | 1 m | New 8,00 |
| Prolyte | H40R L200 | 2 m | New 16,00 |
| Prolyte | H40R L300 | 3 m | New 24,00 |
| Prolyte | Box Corner | | New 24,00 |

| | | | |
|--------------------------------------|--|--------|--------|
| Circles 300 - Triangle Silver | | | |
| Prolyte / ASD | | ø 2 m | 40,00 |
| Prolyte / ASD | | ø 3 m | 50,00 |
| Prolyte / ASD | | ø 4 m | 75,00 |
| Prolyte / ASD | | ø 5 m | 90,00 |
| Prolyte / ASD | | ø 6 m | 120,00 |
| Prolyte / ASD | | ø 8 m | 180,00 |
| Prolyte / ASD | | ø 10 m | 220,00 |
| Prolyte / ASD | | ø 12 m | 250,00 |

| | | | |
|------------------------------------|--|--------|--------|
| Circles 300 - Square Silver | | | |
| Prolyte / ASD | | ø 4 m | 135,00 |
| Prolyte / ASD | | ø 6 m | 190,00 |
| Prolyte / ASD | | ø 8 m | 230,00 |
| Prolyte / ASD | | ø 10 m | 250,00 |
| Prolyte / ASD | | ø 12 m | 275,00 |



► Prolyte / ASD
H30V Black

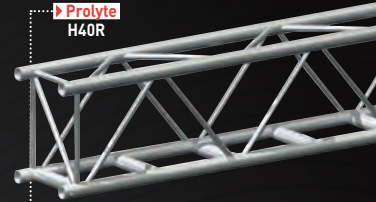

► Prolyte
H40R



► Prolyte
H40R Box

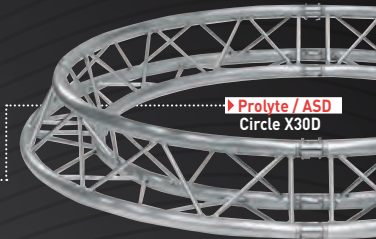

► Prolyte / ASD
Circle X30D

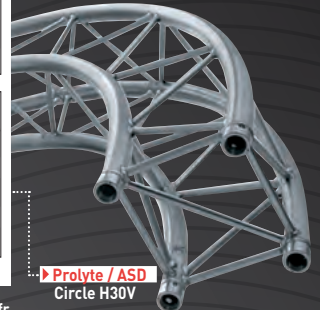

► Prolyte / ASD
Circle H30V

| BRAND | TYPE | SPECIFICATIONS | PRICE / DAY € |
|-----------------------------------|------|----------------|---------------|
| Circles 300 - Square Black | | | |
| ASD | H30V | ø 3 m | 150,00 |
| ASD | H30V | ø 8 m | 300,00 |

| | | | |
|---------------------------------------|------------------|--------------------------------------|-------|
| Ground Supports - 1 ton Silver | | | |
| Prolyte | Tower 1 T - H30V | Base + sleeve + top + 1 x H30V 0,5 m | 50,00 |
| Prolyte | Tower 1 T - H40R | Base + sleeve + top + 1 x H30V 0,5 m | 55,00 |
| Prolyte | | Long Outtrigger set for 1 ton | 25,00 |

| | | | |
|--------------------------------------|------------------|--------------------------------------|-------|
| Ground Supports - 1 ton Black | | | |
| Prolyte | Tower 1 T - H30V | Base + sleeve + top + 1 x H30V 0,5 m | 60,00 |
| Prolyte | Tower 1 T - H40R | Base + sleeve + top + 1 x H30V 0,5 m | 65,00 |
| Prolyte | | Long Outtrigger set for 1 ton | 25,00 |

| | | | |
|----------------------|-------|------------------------------------|--------|
| Speaker Tower | | | |
| ASD | ST780 | Angle + top + sliding block (pair) | 250,00 |

| | | | |
|-----------------------------|----------|-------------------------------------------------------------------------|--------------------------|
| Trussing Accessories | | | |
| YES | STAC01 | 150 Pins & clips + 8 x couplers + hammer + Wrench 13 for 30 & 40 series | 20,00 |
| YES | STAC02 | 80 Pins & clips FOR 500 series | 25,00 |
| Prolyte | STAC04 | Truss - CCS6-603 | 0,25 |
| Prolyte | STAC05 | Truss - CCS6-605 | 0,10 |
| Prolyte | STAC06 | Truss - CCS6-600-H | 0,50 |
| Prolyte | STAC07 | Truss - CCS6-602 | 0,50 |
| Doughty | STAC11A | Double Swivel C-Clamp Silver | 3,00 |
| Doughty | STAC11B | Double Swivel C-Clamp Black | 3,50 |
| Doughty | STAC12 | Spigot 28 mm | 0,75 |
| Doughty | STAC13 | Spigot 28 mm with C-Clamp | 2,00 |
| Doughty | STAC14 | Spigot 16 mm | 0,50 |
| YES | STAC015A | Top totem Silver for series 30 / 40 | 8,00 |
| YES | STAC015B | Top totem Black for series 30 / 40 | 10,00 |
| Avenger | STAC016 | C100 Clamp for spigot 28 mm | 3,00 |
| Doughty | STAC017 | Quick trigger Clamp | 0,50 |
| Doughty | STAC018 | Twenty clamp | 0,50 |
| YES | STACT... | Tube Alu 0,5 m - 6 m | Price per m : 0,25/0,5 m |
| YES | STACT... | Tube Alu Black 0,5 m - 6 m | Price per m : 0,50/0,5 m |
| YES | STACT... | Tube Métal Black 0,5 m - 6 m | Price per m : 0,60/0,5 m |

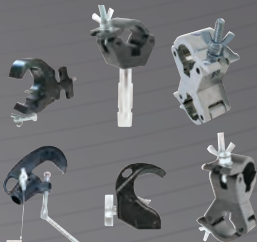
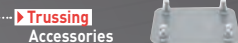
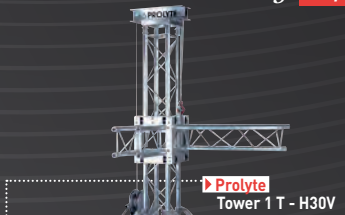



Rigging

| BRAND | TYPE | SPECIFICATIONS | PRICE / DAY € |
|-----------------------|--------|---------------------------------------------------------|---------------|
| Rigging Hoists | | | |
| Verlinde | PHD | Manual hoist 0,5 Ton | 15,00 |
| Verlinde | PHD | Manual hoist 1 Ton | 20,00 |
| Prolyft | PLE-10 | Electric hoist (4-pin) 0,25 Ton - (Chain 20m, 4 m/min.) | 30,00 |
| Prolyft | PLE-11 | Electric hoist (4-pin) 0,5 Ton - (Chain 20m, 4 m/min.) | 45,00 |
| YES | V4 | Controllers 4 - 32A, 4 x CEE16 (4-pin) + Harting | 30,00 |
| YES | V8 | Controllers 8 - 32A, 8 x CEE16 (4-pin) + Harting | 40,00 |
| YES | V12 | Controllers 12 - 32A, 12 x CEE16 (4-pin) + Harting | 60,00 |
| YES | V20 | Controllers 20 - 63A, 20 x CEE16 (4-pin) + Harting | 100,00 |

Rigging cables

| | | | |
|-------------------|-----------------|----------------------------------------------------------------------------------------------------------------------------|-------|
| Nexan | CEE 16A (4G2,5) | 5 m | 1,20 |
| Nexan | CEE 16A (4G2,5) | 10 m | 2,00 |
| Nexan | CEE 16A (4G2,5) | 20 m | 4,00 |
| YES | Kit Hoist | 5 x 5 m, 5 x 10 m, 5 x 20 m CEE 16 Tri 4 Pin 3 x Harting → 4 x CEE 16 Tri 4 Pin 12 x conv. 4 Pin male → 5 Pin female | 55,00 |
| YES | Adaptator | CEE16A 4 pin M. → CEE16A 4 pin F. | 2,00 |
| YES | Adaptator | 5 pin male → 4 pin female | 2,00 |
| Harting / Titanex | Adaptator | Harting → 4 x CEE 16 Tri female | 4,00 |
| Titanex / Harting | Adaptator | 4 x CEE 16 Tri male → Harting | 4,00 |

Accessories

| | | | |
|---------|----------|----------------------------------------------------------------------------|-----------|
| YES | STAC01 | 150 Pins & clips + 8 x couplers + hammer + Wrench 13 for 30 & 40 series | 20,00 |
| YES | STAC02 | 80 Pins & clips FOR 500 series | 25,00 |
| Prolyte | STAC04 | Truss - CCS6-603 | 0,25 |
| Prolyte | STAC05 | Truss - CCS6-605 | 0,10 |
| Prolyte | STAC06 | Truss - CCS6-600-H | 0,50 |
| Prolyte | STAC07 | Truss - CCS6-602 | 0,50 |
| Doughty | STAC11A | Double Swivel C-Clamp Silver | 3,00 |
| Doughty | STAC11B | Double Swivel C-Clamp Black | 3,50 |
| Doughty | STAC12 | Spigot 28 mm | 0,75 |
| Doughty | STAC13 | Spigot 28 mm with C-Clamp | 2,00 |
| Doughty | STAC14 | Spigot 16 mm | 0,50 |
| YES | STAC015A | Top totem Silver for series30 / 40 | 8,00 |
| YES | STAC015B | Top totem Black for series30 / 40 | 10,00 |
| Avenger | STAC016 | C100 Clamp for spigot 28 mm | 3,00 |
| Doughty | STAC017 | Quick trigger Clamp | 0,50 |
| Doughty | STAC018 | Twenty clamp | 0,50 |
| YES | STACT... | Tube Alu 0,5 m - 6 m | 0,25/0,5m |
| YES | STACT... | Tube Alu Black 0,5 m - 6 m | 0,50/0,5m |
| YES | STACT... | Tube Steel Black 0,5 m - 6 m | 0,60/0,5m |



▶ Verlinde
PHD 0,5 Ton

▶ Verlinde
PHD 1 Ton

▶ Prolyft
PLE-10



▶ Prolyft
PLE-11



▶ Rigging
Accessories



BRAND TYPE SPECIFICATIONS PRICE / DAY €

Stands - Grips

| | | | |
|-----------|----------------|-----------------------------------------------------|-------|
| Manfrotto | Wind Up 087 | Stand | 12,50 |
| Manfrotto | 007CSU | Stand | 8,00 |
| VMB | TL-054 | Stand | 35,00 |
| VMB | TLA-320 | Stand for Line-Array (max 250 kg) | 65,00 |
| Manfrotto | Autopole | 2,1 → 3,7 m | 15,00 |
| Manfrotto | Operating pole | 1,9 → 4,0 m | 12,50 |
| Manfrotto | Operating pole | 2,2 → 6,5 m | 15,00 |
| Manfrotto | G200 | Ballast - 10 kg | 7,50 |
| Manfrotto | 143N | Magic Arm | 7,50 |
| Avenger | C825 | Telescopic Hanger & Unihead | 10,00 |
| Avenger | C100 | A clamp that works on diameters from 20 mm to 55 mm | 1,00 |

Rigging - Steel

| | | | |
|--------|-----------------|---------------------------------------------|-------|
| APL | Steel | 1 Ton - 4 m | 1,50 |
| APL | Steel | 1 Ton - 6 m | 2,00 |
| APL | Steel | 1 Ton - 8 m | 2,50 |
| APL | Steel | 1 Ton - 10 m | 3,00 |
| APL | Steel | 1 Ton Plastified - 4 m | 2,00 |
| APL | Steel | 1 Ton Plastified - 6 m | 2,50 |
| APL | Steel | 1 Ton Plastified - 2 m with O-Ring and hook | 2,50 |
| APL | Steel | 1 Ton Plastified - 4 m with O-Ring and hook | 3,50 |
| Beneca | Softsteel | 2 Ton - 0,5 m | 0,75 |
| Beneca | Softsteel | 2 Ton - 1 m | 1,00 |
| Beneca | Softsteel | 2 Ton - 1,6 m | 1,30 |
| Beneca | Softsteel | 2 Ton - 2 m | 1,50 |
| Beneca | Softsteel | 2 Ton - 3 m | 2,00 |
| Crosby | Harp - Schackle | 2 Ton | 0,25 |
| Crosby | Harp - Schackle | 3,25 Ton | 0,40 |
| Yale | Beamclamp | 1 Ton (75 - 210 mm) | 10,00 |
| Yale | Beamclamp | 3 Ton (80 - 320 mm) | 12,50 |
| Grosby | O-Ring | 3 Ton | 1,00 |
| APL | Varichain | 0,2 m à 2 m - 1 Ton | 5,00 |
| YES | Safety steel | 100 Kg - 50 cm | 0,40 |
| YES | Safety steel | 100 Kg - 70 cm | 0,50 |
| YES | Safety steel | 100 Kg - 100 cm | 0,75 |
| YES | Ratched Strap | 2 m - 1 200 kg - 200 daN | 2,00 |
| YES | Ratched Strap | 4 m - 1 200 kg - 200 daN | 3,00 |
| YES | Ratched Strap | 6 m - 1 200 kg - 200 daN | 5,00 |

Skyworkers - Working at height - Handling

| | | | |
|----------|-----------------|-------------------------|--------|
| Altrex | Ladder | 3 arms - 12 steps | 35,00 |
| Altrex | Stepladder | 7 steps | 22,50 |
| Altrex | Stepladder | 5 steps | 20,00 |
| Petzel | Flexible ladder | 10 m / Max force 8,5 KN | 10,00 |
| Petzel | Rolling safety | max 135 kg - 15 m | 70,00 |
| Genie | Personal Lift | 9 m Working Height | 160,00 |
| Genie | Personal Lift | 13 m Working Height | 200,00 |
| Eurofeet | Pallet truck | | 10,00 |





Energy/Cabling

| BRAND | TYPE | SPECIFICATIONS | PRICE / DAY € |
|---------------------------|------------|-------------------------------------------------------------------------------------------------|---------------|
| Power Supply Units | | | |
| 32A | | | |
| Vello | ELEC32D01 | IN 32A → OUT 6 x 16A Schuko - 6 x 16A Mono - 1 x link 32A Tri | 40,00 |
| YES | ELEC32D02 | CEE 32A - 380 V (3 m cabling) → 3 x 32A Mono 220V | 10,00 |
| YES | ELEC32D03 | CEE 32A Mono - 220 V (3 m cabling) → 6 x 16A Schuko | 12,50 |
| 63A | | | |
| Vello | ELEC63M01 | IN 63A → OUT 3 x Harting - 4 x Socapex 2 x CEE 32A - 1 x link CEE 63A Tri | 55,00 |
| Vello | ELEC63D01 | IN 63A → OUT 2 x 32A - 6 x 32A mono - 3 x 16A Schuko 3 x CEE 16A Mono - 1 x link 63A | 55,00 |
| Vello | ELEC63D02 | CEE 63A Tri ma le (3 m cabling) → 2 x 32A Tri female (box) | 35,00 |
| 125A | | | |
| Vello | ELEC125D01 | IN 125A → OUT 2 x 63A - 2 x 32A - 3 x 16A Schuko 3 x CEE 16A Mono - 1 x link 125A | 75,00 |
| Vello | ELEC125M01 | IN 125A → OUT 6 x Harting - 8 x Socapex 3 x 16A Schuko - 3 x CEE 16A Mono 1 x link 125A | 110,00 |
| 250A | | | |
| Vello | ELEC250D01 | IN 250A → OUT 2 x 125A - 2 x 63A - 2 x 32A 3 x 16A Schuko - 3 x CEE 16A Mono - 1 x link 250A | 120,00 |
| Vello | ELEC250M01 | IN 250A → OUT 12 x Harting - 16 x Socapex 3 x 16A Schuko - 3 x CEE 16A Mono - 1 x link 250A | 160,00 |
| 400A | | | |
| Vello | ELEC400D01 | IN 400A → OUT 3 x 125A - 3 x 63A - 3 x 32A 3 x 16A Schuko - 3 x CEE 16A Mono - 1 x link 400A | 180,00 |

Cables

Schuko

| | | | |
|-------|-------|---------------|------|
| Keraf | Nexan | 3G2,5 - 1,5 m | 0,50 |
| Keraf | Nexan | 3G2,5 - 3 m | 0,60 |
| Keraf | Nexan | 3G2,5 - 5 m | 1,00 |
| Keraf | Nexan | 3G2,5 - 10 m | 2,00 |
| Keraf | Nexan | 3G2,5 - 20 m | 4,00 |

Powercon

| | | | |
|---------|-------|----------------|------|
| Neutrik | Nexan | 3G2,5 - 0,75 m | 0,40 |
| Neutrik | Nexan | 3G2,5 - 1,5 m | 0,50 |
| Neutrik | Nexan | 3G2,5 - 3 m | 0,60 |
| Neutrik | Nexan | 3G2,5 - 5 m | 1,00 |
| Neutrik | Nexan | 3G2,5 - 10 m | 2,00 |



Nexan
Schuko extension



Nexan
Powercon extension

Power Supply Unit



▶ Vello
ELEC01

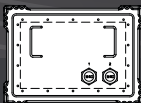
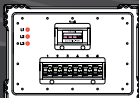

▶ Vello
ELECPATCH01

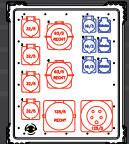
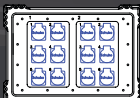

▶ Vello
ELEC125D01

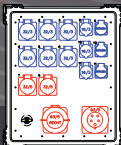

▶ Vello
ELEC63D01

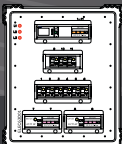

▶ Vello
ELEC63M01

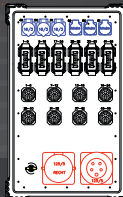
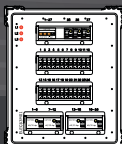

▶ Vello
ELEC125M01

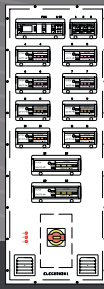
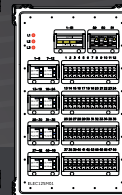

▶ Vello
ELEC250D01

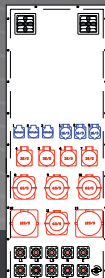

▶ Vello
ELEC250M01

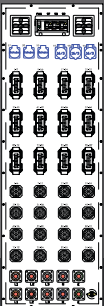

▶ Vello
ELEC400D01

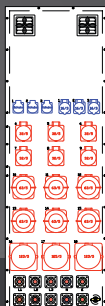

| BRAND | TYPE | SPECIFICATIONS | PRICE / DAY € |
|----------------------|-------|-----------------------|---------------|
| Cables | | | |
| CEE 16A Mono | | | |
| Keraf | Nexan | 3G2,5 1,5 m | 0,50 |
| Keraf | Nexan | 3G2,5 3 m | 0,60 |
| Keraf | Nexan | 3G2,5 5 m | 1,00 |
| Keraf | Nexan | 3G2,5 10 m | 2,00 |
| Keraf | Nexan | 3G2,5 20 m | 4,00 |
| CEE 16A Tri | | | |
| PCE | Nexan | 5G2,5 5 m | 2,00 |
| PCE | Nexan | 5G2,5 10 m | 3,00 |
| PCE | Nexan | 5G2,5 20 m | 6,00 |
| CEE 32A Mono | | | |
| PCE | Nexan | 3G6 3 m | 0,75 |
| PCE | Nexan | 3G6 5 m | 1,25 |
| PCE | Nexan | 3G6 10 m | 2,50 |
| PCE | Nexan | 3G6 20 m | 6,25 |
| PCE | Nexan | 3G6 50 m | 13,00 |
| CEE 32A Tri | | | |
| PCE | Nexan | 5G6 1,5 m | 1,00 |
| PCE | Nexan | 5G6 3 m | 1,50 |
| PCE | Nexan | 5G6 5 m | 2,50 |
| PCE | Nexan | 5G6 10 m | 5,00 |
| PCE | Nexan | 5G6 20 m | 10,00 |
| PCE | Nexan | 5G6 25 m | 12,50 |
| PCE | Nexan | 5G6 50 m | 25,00 |
| CEE 63A | | | |
| PCE | Nexan | 5G16 3 m | 1,50 |
| PCE | Nexan | 5G16 5 m | 2,50 |
| PCE | Nexan | 5G16 10 m | 5,00 |
| PCE | Nexan | 5G16 20 m | 10,00 |
| PCE | Nexan | 5G16 25 m | 12,50 |
| PCE | Nexan | 5G16 50 m | 25,00 |
| CEE 125A | | | |
| PCE | Nexan | 5G25 3 m | 2,50 |
| PCE | Nexan | 5G25 5 m | 4,00 |
| PCE | Nexan | 5G25 10 m | 8,00 |
| PCE | Nexan | 5G25 20 m | 16,00 |
| PCE | Nexan | 5G25 25 m | 20,00 |
| Set Powerlock | | | |
| Powersyntax | Nexan | 120 ² 3 m | 15,00 |
| Powersyntax | Nexan | 120 ² 5 m | 25,00 |
| Powersyntax | Nexan | 120 ² 10 m | 50,00 |
| Powersyntax | Nexan | 120 ² 25 m | 125,00 |



► Nexan
CEE extension



► Powersyntax
Set Powerlock

| BRAND | TYPE | SPECIFICATIONS | PRICE / DAY € |
|------------------------------------|-------------------------|---------------------------------------------|---------------|
| Adaptators | | | |
| Adaptator Schuko / Powercon | | | |
| Perel | Domino | 4 x Schuko 1,52 - 1,5 m | 0,50 |
| Perel | Domino | 4 x Schuko 2,52 - 1,5 m | 0,75 |
| Schuko / Neutrik | Schuko male | → Powercon female - 0,75 m | 0,50 |
| Neutrik / Schuko | Powercon male | → Schuko female - 0,75 m | 0,50 |
| Bals / Schuko | CEE 16A Mono male | → Schuko female - 0,75 m | 1,00 |
| Schuko / Bals | Schuko male | → CEE 16A Mono female - 0,75 m | 1,00 |
| Adaptator 32A | | | |
| PCE | Break in - CEE 32A Mono | | 2,00 |
| PCE | Break in - CEE 32A Tri | | 2,00 |
| PCE | CEE 32A Mono male | → 2 x Schuko | 3,00 |
| PCE | CEE 32A Mono male | → 6 x Schuko (box) | 15,00 |
| PCE | CEE 32A Tri male | → 1 x 63A Tri female | 4,00 |
| Adaptator 63A | | | |
| PCE | Break in - CEE 63A Tri | | 3,00 |
| PCE | CEE 63A Tri male | → CEE 125A Tri female | 5,00 |
| PCE | CEE 63A Tri male | → 2 x 32A Tri female | 6,00 |
| PCE | CEE 63A Tri male | → 1 x 32A Tri female | 4,00 |
| Adaptator 125A | | | |
| PCE | Break in - CEE 63A Tri | | 4,00 |
| PCE | CEE 125A Tri male | → 2 x 63A Tri female | 6,00 |
| PCE | CEE 125A Tri male | → 1 x 63A Tri female | 5,00 |
| PCE | CEE 125A Tri male | → Powerlock | 12,50 |
| Adaptator Powerlock | | | |
| Powersyntax | Break in - Powerlock | | 15,00 |
| Powersyntax | Powerlock | → CEE 125A Tri female | 12,50 |
| Adaptator Multicable | | | |
| Harting | Box (break out) | Harting 16p male → 8 x Schuko female + link | 4,00 |
| Harting / Keraf | Spider (break out) | Harting 16p male → 8 x Schuko female | 4,00 |
| Harting / Bals | Spider (break out) | Harting 16p male → 4 x CEE 16 female | 4,00 |
| Harting / Keraf | Spider (break out) | Harting 16p male → 8 x CEE 16A Mono | 5,00 |
| Keraf / Harting | Spider (break in) | 8 x Schuko male → Harting 16p female | 4,00 |
| Socapex / Keraf | Box (break out) | Socapex 419 → 6 x Schuko femal + link | 4,00 |
| Socapex / Keraf | Spider (break out) | Socapex 419 → 6 x Schuko female | 4,00 |
| Socapex / Keraf | Box (break out) | Socapex 419 → 6 x CEE 16A Mono + link | 4,50 |
| Keraf / Socapex | Spider (break in) | 6 x Schuko male → Socapex 419 | 4,00 |
| Keraf / Socapex | Spider (break in) | 6 x CEE 16A Mono → Socapex 419 | 5,00 |
| Harting / Socapex | Adaptator | Harting 16p male → Socapex 419 | 6,00 |
| Harting / Socapex | Adaptator | Socapex 419 → Harting 16p female | 6,00 |

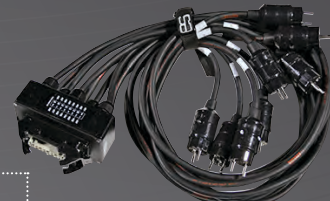
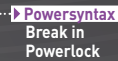

BRAND TYPE SPECIFICATIONS PRICE / DAY €

Multicables**Harting**

| | | | |
|---------|------------------------|------|-------|
| Harting | 16P - 2,5 ² | 5 m | 2,00 |
| Harting | 16P - 2,5 ² | 10 m | 4,00 |
| Harting | 16P - 2,5 ² | 15 m | 6,00 |
| Harting | 16P - 2,5 ² | 20 m | 8,00 |
| Harting | 16P - 2,5 ² | 25 m | 10,00 |

Socapex

| | | | |
|---------|------------------------|------|-------|
| Socapex | 419 - 2,5 ² | 5 m | 2,50 |
| Socapex | 419 - 2,5 ² | 10 m | 5,00 |
| Socapex | 419 - 2,5 ² | 15 m | 7,50 |
| Socapex | 419 - 2,5 ² | 20 m | 10,00 |
| Socapex | 419 - 2,5 ² | 25 m | 12,50 |

Light Cables**DMX 3**

| | | | |
|----------------|------------|--------------|-------|
| Neutrik/Sommer | DMX 3 pins | 1,5 m | 0,50 |
| Neutrik/Sommer | DMX 3 pins | 3 m | 0,60 |
| Neutrik/Sommer | DMX 3 pins | 5 m | 0,75 |
| Neutrik/Sommer | DMX 3 pins | 10 m | 1,50 |
| Neutrik/Sommer | DMX 3 pins | 20 m | 3,00 |
| Neutrik/Sommer | DMX 3 pins | 50 m on drum | 12,50 |

DMX 5

| | | | |
|----------------|------------|---------------|-------|
| Neutrik/Sommer | DMX 5 pins | 1,5 m | 0,50 |
| Neutrik/Sommer | DMX 5 pins | 3 m | 0,60 |
| Neutrik/Sommer | DMX 5 pins | 5 m | 0,75 |
| Neutrik/Sommer | DMX 5 pins | 10 m | 1,50 |
| Neutrik/Sommer | DMX 5 pins | 20 m | 3,00 |
| Neutrik/Sommer | DMX 5 pins | 50 m on drum | 12,50 |
| Neutrik/Sommer | DMX 5 pins | 100 m on drum | 17,50 |

DMX Adaptator

| | | | |
|---------|------------|-----------------------------|------|
| Neutrik | Adaptateur | 3 pins Male → 5 pins female | 0,50 |
| Neutrik | Adaptateur | 5 pins Male → 3 pins female | 0,50 |
| Neutrik | Adaptateur | End stopper | 1,00 |

▶ Harting
Multicables▶ Socapex
Multicables▶ Neutrik/Sommer
DMX 3 pins▶ Neutrik/Sommer
DMX 5 pins▶ Neutrik/Sommer
5 pins Male
→ 3 pins Female

| BRAND | TYPE | SPECIFICATIONS | PRICE / DAY € |
|---------------------|----------------------------------------------------------------------|----------------|---------------------|
| Sound Cables | | | |
| Speakon NL4 | | | |
| Neutrik | Belden | Speakon Cable | 0,6 m 0,20 |
| Neutrik | Belden | Speakon Cable | 1,2 m 0,40 |
| Neutrik | Belden | Speakon Cable | 3 m 0,60 |
| Neutrik | Belden | Speakon Cable | 5 m 1,00 |
| Neutrik | Belden | Speakon Cable | 10 m 2,00 |
| Neutrik | Belden | Speakon Cable | 20 m 4,00 |
| XLR | | | |
| Neutrik | Belden | XLR Cable | 1 m 0,15 |
| Neutrik | Belden | XLR Cable | 2 m 0,30 |
| Neutrik | Belden | XLR Cable | 3 m 0,45 |
| Neutrik | Belden | XLR Cable | 5 m 0,75 |
| Neutrik | Belden | XLR Cable | 10 m 1,50 |
| Neutrik | Belden | XLR Cable | 20 m 3,00 |
| Neutrik | Belden | XLR Cable | 50 m on drum 10,00 |
| Neutrik | Belden | XLR Cable | 100 m on drum 17,50 |
| Adapator | | | |
| Neutrik | UTP RJ45 - RJ45 | | 1,00 |
| Neutrik | Speakon NL4 - NL4 | | 1,50 |
| YES | Z-split (2 x XLR 3M → 2 x XLR 3F) | | 2,00 |
| Axcept | Adaptator Tool | | |
| | 2 x jack Mono 6,5 M → XLR 3F, 2 x jack Mono 6,5 M → XLR 3 M | | |
| | 2 x jack Stereo 6,5 M → XLR 3F, 2 x jack Stereo 6,5 M → XLR 3 M | | |
| | 2 x jack Stereo 6,5 F → XLR 3F, 2 x jack Stereo 6,5 F → XLR 3 M | | |
| | 2 x Cinch F → XLR 3F, 2 x Cinch F → XLR 3M, 2 x Cinch M → XLR 3 F, | | |
| | 2 x Cinch M → XLR 3M, 2 x BNC F → XLR 3 F, 2 x BNC F → XLR 3 M | | |
| | 2 x XLR 3 M → XLR 3 M, 2 x XLR 3 F → XLR 3 F, 2 x XLR 5 F → XLR 3 M, | | |
| | 2 x XLR 5 M → XLR 3 F, 4 x XLR 3 Phase inverter, 4 x NL4 M → NL4 M | | 30,00 |



▶ Neutrik
Speakon Cabling



▶ Neutrik
XLR cable



| BRAND | TYPE | SPECIFICATIONS | PRICE / DAY € |
|--------------------------------------------------------------------------|---------------|----------------------------------------------------------------------------------------------------------------------------|---------------|
| Cable Kit New | | | |
| YES | Kit Schuko | 10 x 1,5 m, 10 x 3 m, 10 x 5 m, 10 x 10 m, 5 x 20 m, 20 x Domino | 60,00 |
| YES | Kit DMX 3 | 10 x 1,5 m, 10 x 3 m, 10 x 5 m, 10 x 10 m, 5 x 20 m | 55,00 |
| YES | Kit DMX 5 | 10 x 1,5 m, 10 x 3 m, 10 x 5 m, 10 x 10 m, 5 x 20 m | 55,00 |
| YES | Kit Harting01 | 10 x 5 m, 10 x 10 m | 55,00 |
| YES | Kit Harting02 | 5 x 15 m, 5 x 20 m | 75,00 |
| YES | Kit Harting03 | 10 x 25 m | 80,00 |
| YES | Kit Socapex01 | 10 x 25 m | 80,00 |
| YES | Kit Socapex02 | 10 x 5 m, 10 x 10 m | 65,00 |
| YES | Kit Hoist | 5 x 5 m, 5 x 10 m, 5 x 20 m CEE 16 Tri 4 Pin 3 x Harting → 4 x CEE 16 Tri 4 Pin 12 x conv. 4 Pin male → 5 Pin female | 55,00 |



▶ YES
Schuko Kit



▶ YES
XLR 3 Kit



▶ YES
XLR 5 Kit



▶ YES
Harting 01 Kit



▶ YES
Harting 02 Kit



▶ YES
Harting 03 Kit



▶ YES
Socapex 01 Kit



▶ YES
Socapex 02 Kit



Stage / Accessories

Stage / Accessories

YES
Rental

| BRAND | TYPE | SPECIFICATIONS | PRICE / DAY € |
|--------------|--------------------|-------------------------|---------------|
| Stage | | | |
| Prolyte | Stagedex | 2 x 1 m - max. 750 kg | 10,00 |
| Prolyte | Stagedex | 1 x 1 m - max. 750 kg | 8,00 |
| Prolyte | Stagedex | 2 x 0,5 m - max. 750 kg | 8,00 |
| Prolyte | Stagedex | 1 x 0,5 m - max. 750 kg | New 8,00 |
| Prolyte | Guardrail Stagedex | | New 100,00 |
| Prolyte | Deck to Deck Clamp | | New 0,50 |
| Axept | Stair | 0,2 m à 1 m | 15,00 |
| Axept | Railing | | 5,00 |
| YES | Leg | 0,2m | 0,20 |
| YES | Leg | 0,4 m | 0,20 |
| YES | Leg | 0,6 m | 0,40 |
| YES | Leg | 0,8 m | 0,40 |
| YES | Leg | 1 m | 0,60 |
| YES | Leg | 1,2 m | 0,60 |

Folding tent

| | | |
|---------|---------------------------------------------|--------|
| Vitabri | 6 m x 3 m | 100,00 |
| Vitabri | 4,5 m x 3 m | 80,00 |
| Vitabri | Side walls for folding tent for 4,5 m x 3 m | 20,00 |
| Vitabri | Side walls for folding tent for 6 m x 3 m | 25,00 |
| Vitabri | Ballast for folding tent - 15 kg | 5,00 |

Working at height - Handling

| | | | |
|----------|-----------------|-------------------------|-----------|
| Altrex | Ladder | 3 arms - 12 steps | 35,00 |
| Altrex | Stepladder | 7 steps | 22,50 |
| Altrex | Stepladder | 5 steps | 20,00 |
| Petzel | Flexible ladder | 10 m / Max force 8,5 KN | 10,00 |
| Petzel | Rolling safety | max 135kg - 15m | New 70,00 |
| Genie | Personal Lift | 9 m Working Height | 160,00 |
| Genie | Personal Lift | 13 m Working Height | 200,00 |
| Eurofeet | Pallet truck | | 10,00 |



► Prolyte
Stagedex



► Prolyte
Guardrail Stage Dex

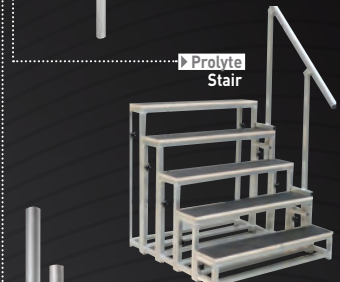

► Prolyte
Stair

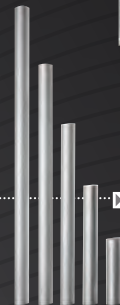

► YES
Leg



► YES
Stage Rigging

Stage / Accessories

YES
Rental

BRAND TYPE SPECIFICATIONS PRICE / DAY €

Textile

Black

| | | |
|-----|-----------------------------|--------------------|
| YES | Backdrops W 3 m / H 3,5 m | (Net Prices) 13,15 |
| YES | Backdrops W 4,5 m / H 3,5 m | (Net Prices) 20,00 |
| YES | Backdrops W 6 m / H 3,5 m | (Net Prices) 26,25 |
| YES | Backdrops W 3 m / H 6 m | (Net Prices) 22,50 |
| YES | Backdrops W 4,5 m / H 6 m | (Net Prices) 33,75 |
| YES | Backdrops W 6 m / H 6 m | (Net Prices) 45,00 |

White

| | | |
|-----|-----------------------------|--------------------|
| YES | Backdrops W 3 m / H 3,5 m | (Net Prices) 26,25 |
| YES | Backdrops W 4,5 m / H 3,5 m | (Net Prices) 39,38 |
| YES | Backdrops W 6 m / H 3,5 m | (Net Prices) 52,50 |

Pipe and Drapes

| | | |
|--------|--------------------------------|------------------------------------------------------------------------------------------|
| WENTEX | 8 x Uprights 1,8 m to 4,2 m |  350,00 |
| | 8 x Drape Support 1,8 m to 3 m | |
| | 8 x Baseplates | |

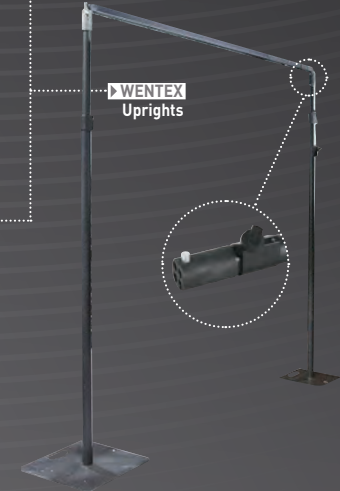



Various

Transport

| Size | Price / km | Minimum Price |
|--------------------|------------|------------------|
| car | 0,35 | |
| 6 m ³ | 0,45 | 50 euros |
| 15 m ³ | 0,55 | 65 euros |
| 20 m ³ | 0,7 | 75 euros |
| 50 m ³ | 1 | 200 euros |
| 100 m ³ | 1,5 | 300 euros |

Staffel

| Days of rent | Staffel | Weeks of rent | Staffel | Weeks of rent | Staffel |
|--------------|----------|---------------|----------|---------------|----------|
| 1 day | = x 1 | 5 weeks | = x 4,5 | 33 weeks | = x 18,5 |
| 2 days | = x 1,5 | 6 weeks | = x 5 | 34 weeks | = x 19 |
| 3 days | = x 1,6 | 7 weeks | = x 5,5 | 35 weeks | = x 19,5 |
| 4 days | = x 1,7 | 8 weeks | = x 6 | 36 weeks | = x 20 |
| 5 days | = x 1,8 | 9 weeks | = x 6,5 | 37 weeks | = x 20,5 |
| 6 days | = x 1,9 | 10 weeks | = x 7 | 38 weeks | = x 21 |
| 7 days | = x 2 | 11 weeks | = x 7,5 | 39 weeks | = x 21,5 |
| 8 days | = x 2,5 | 12 weeks | = x 8 | 40 weeks | = x 22 |
| 9 days | = x 2,6 | 13 weeks | = x 8,5 | 41 weeks | = x 22,5 |
| 10 days | = x 2,7 | 14 weeks | = x 9 | 42 weeks | = x 23 |
| 11 days | = x 2,8 | 15 weeks | = x 9,5 | 43 weeks | = x 23,5 |
| 12 days | = x 2,9 | 16 weeks | = x 10 | 44 weeks | = x 24 |
| 13 days | = x 2,95 | 17 weeks | = x 10,5 | 45 weeks | = x 24,5 |
| 14 days | = x 3 | 18 weeks | = x 11 | 46 weeks | = x 25 |
| 15 days | = x 3,1 | 19 weeks | = x 11,5 | 47 weeks | = x 25,5 |
| 16 days | = x 3,2 | 20 weeks | = x 12 | 48 weeks | = x 26 |
| 17 days | = x 3,3 | 21 weeks | = x 12,5 | 49 weeks | = x 26,5 |
| 18 days | = x 3,35 | 22 weeks | = x 13 | 50 weeks | = x 27 |
| 19 days | = x 3,4 | 23 weeks | = x 13,5 | 51 weeks | = x 27,5 |
| 20 days | = x 3,45 | 24 weeks | = x 14 | 52 weeks | = x 28 |
| 21 days | = x 3,5 | 25 weeks | = x 14,5 | | |
| 22 days | = x 4 | 26 weeks | = x 15 | | |
| 23 days | = x 4 | 27 weeks | = x 15,5 | | |
| 24 days | = x 4 | 28 weeks | = x 16 | | |
| 25 days | = x 4 | 29 weeks | = x 16,5 | | |
| 26 days | = x 4 | 30 weeks | = x 17 | | |
| 27 days | = x 4 | 31 weeks | = x 17,5 | | |
| 28 days | = x 4 | 32 weeks | = x 18 | | |

Maximum 4 days
including transport

YES RENTAL – General terms and conditions for hire

1. Glossary : For the purposes of these terms, is designated by : the first person plural : YES RENTAL SPRL - Our co-contractor : a person who enters with YES RENTAL SPRL.

2. Acceptance of Terms : Our terms and conditions are strictly applied ; our co-contractor cannot unilaterally change them and may only be waived by special terms, expressly agreed between the parties. The terms and conditions of our co-contractor will never be enforceable, even if they appear on the back of the letter accepting our offer. By the mere fact that he deals with us, our co-contractor accepts our conditions and renounces to his own, even if they contain a similar clause.

3. Offer without commitment on our part : Our offers and price lists are purely indicative. They can be retracted or modified at any time. Our contracts will be formed after we received a written order, binding irrevocably our co-contractor, followed by acceptance of the order by us.

4. Termination of Contract : Our co-contractor shall be entitled to terminate the contract unilaterally by the payment of compensation equal to 30 % of the agreed price for the relevant lease. Termination can take place before the delivery of equipment, by registered letter ; the date of first presentation will prevail. In case termination would take place less than a week before the scheduled date for the beginning of the rent, the compensation will be increased to 50 % of the agreed price.

5. Transport : The transport is performed at the expense of our co-contractor. The material is transported at the risk of our co-contractor, who shall ensure that, during the delivery, the contents of the packages are checked in the presence of the deliveryman and will report any problems or comments whatsoever about the material delivered. In case of problems or comments, it is advisable to make specific reference to the transport receipt and in any case, let us know as soon as possible by registered letter.

6. Rental terms : The material is accompanied by a delivery note stating the date of removal and the date of return that have been agreed on the purchase order. The rental period is calculated per day of 24 hours and this, the day of departure on the day of return of the equipment in our facilities. The return date is imperative. Each day of delay is due entirety.

The return of the equipment is made at the expense of our co-contractor, on the date and time provided in the contract documents. Any extension must be notified 24 hours in advance and cannot be done without our consent. If the material isn't returned on time and that the delay prevented us from renting to another customer, we reserve the right to claim the amount of our damage to our co-contractor.

7. No assignment of the rent or subrent : The assignment of a rent or subrent of our material is expressly prohibited.

8. Payment : In the absence of another deadline expressly provided, our invoices are payable 15 days from the date of shipment, without discount or at our headquarters in La Rue de la Paix 24/26 - 7500 Tournai - Belgium, or on the account number IBAN: BE38068894548272 BIC: GKCBEBB. We reserve the right to require a deposit of 50 % payable on the date of the order and on account of the bill. In case of late payment of a single invoice by our co-contractor, for any reason, all our claims, including not yet matured, become without notice, due immediately. We will also have the right to suspend all services to regularize the situation, or to sue for rescission of the contract to the wrongs of our co-contractor and to claim the payment of damages. In any case, we reserve the right to act in termination of the contract and damages after suspending all services. Any delay in payment of our invoices will automatically lead , without notice or further warning, to a default interest of 1,25 % per month started, this interest will be payable from the date of the payment deadline, it stays due even if our statements have do not mention it. Similarly, in case of non-payment of all our invoices when due, the amounts will be automatically and without notice 15 % of their principal amount with a minimum of 50 euros as a penalty clause under Article 1229 of the Civil Code.

9. Reciprocity : Our contracts and our general conditions are governed by the principles of reciprocity of contractual obligations. Unless otherwise specified herein, payments under this contract in our favour may be claimed by our co-contractor in case of non performance of our obligations.

10. Liability insurance : Our co-contractor is liable, upon the issuance of equipment, for any damage whatever the cause, especially in cases of force majeure or fortuitous event, without being able to exercise any remedy against us, unless damages duly recorded in a contradictory manner, and expressly included in delivery note signed between parties at the time of delivery. All costs of repair will be borne exclusively by this restoration to be effective in the fortnight following, without prejudice to the intangible losses incurred thereby by YES Rental. The rented equipment must be used for its intended purpose and our co-contractor must have related to the proper use of equipment expertise, he acknowledges this by signing the order. The co-contractor will be personally responsible for all insurance covers or responsibilities he deems necessary to purchase from insurers of their choice, but with abandon express use of subrogated insurers in favour of YES Rental. The co-contractor shall provide all the documents proving the insurance coverage at the first request of YES Rental.

11. Governing Law and Jurisdiction : Belgian law governs all our contracts. Any dispute regarding the existence, validity, interpretation or performance of our contracts will be the exclusive jurisdiction of the courts of the district of Tournai.

HOW TO FIND US :

BELGIUM

Rue de la Paix, 24 - 26 • B7500 Tournai - Belgium

Tel. +32 (0)69 78 99 30 | Fax +32 (0)69 78 99 39

www.yesrental.be | rental@yesrental.be - GPS : 50° 36' 22" - 3° 24' 24"

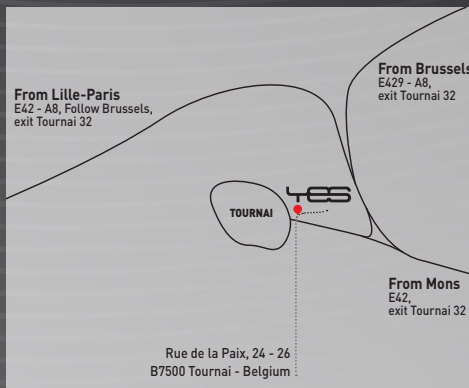
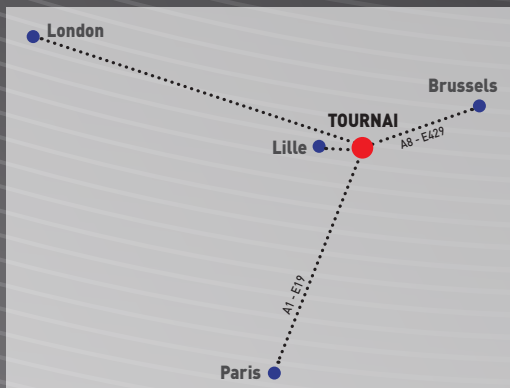

FRANCE

65 / 75 Avenue Jean Mermoz, Espace Paris Mermoz • Zone 8 - Bâtiment i
F 93120 La Courneuve - France

Tel. +33 (0)1 49 21 18 20 | Fax +33 (0)1 49 21 18 21

www.yesrental.fr | location@yesrental.fr - GPS : 48° 55' 56.244" - 2° 24' 16.772"

